

# Metal Shaft Potentiometer 11mm Size Metal Shaft Reflow Type

RK119 Series

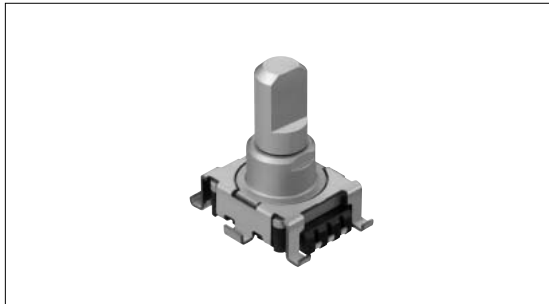

1.5mm-travel push-on switch achieved in a low-profile of only 5mm height.



## Typical Specifications

Items	Specifications
Total resistance tolerance	± 20%
Maximum operating voltage	50V AC, 10V DC
Total rotational angle	300 <sup>+10°</sup> <sub>-5°</sub>
Rotational torque	7.5 ± 3.5mN·m
Operating life	15,000cycles
Operating temperature range	- 40 to +85

## Product Line

### Single-shaft without switch type

Number of resistor elements	Mounting direction	Shaft type	Length of the shaft (mm)	Total resistance (k )	Resistance taper	Switch travel (mm)	Minimum order unit (pcs.)	Products No.	Drawing No.
Single-unit	Vertical type	Flat	20	10	1B	Without	300	RK1191110001	1
						0.5		RK1191114001	2
						1.5		RK1191124001	3

## Note

Products other than those listed in above products are also available. Please contact us for details.

Rotary Potentiometers

Slide Potentiometers

Metal Shaft

Insulated Shaft



Knob Operating

**Dimensions**

Unit:mm

Rotary Potentiometers  
 Slide Potentiometers

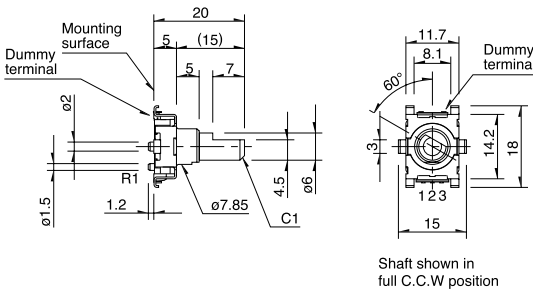
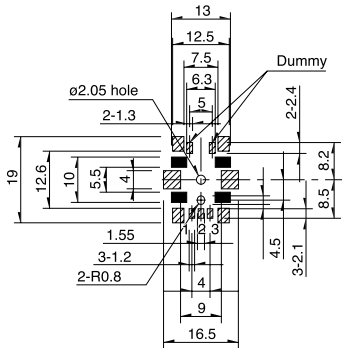
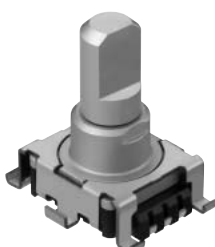
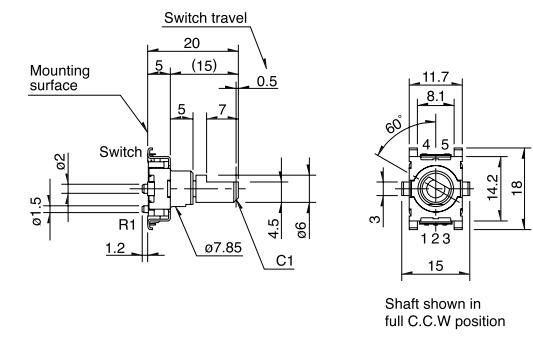
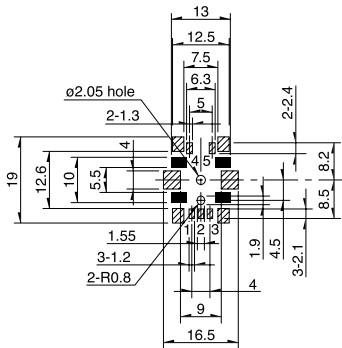
Metal Shaft  
 Insulated Shaft  
 Knob Operating

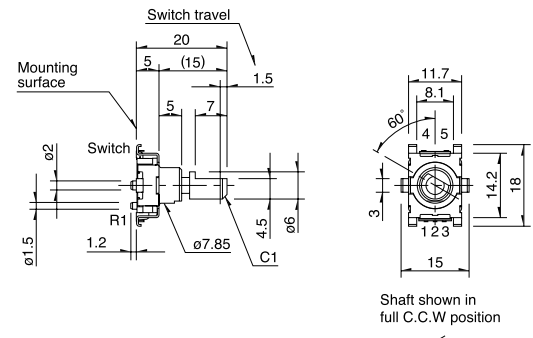
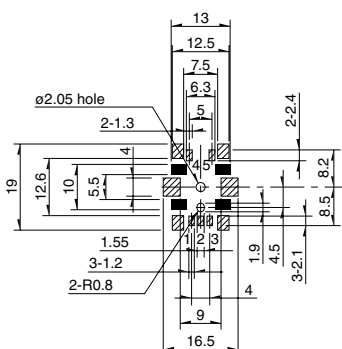
No.	Photo	Style	PC board mounting hole dimensions (Viewed from mounting side)
1	<p><b>Single-shaft, single-unit RK1191110001</b></p> 	 <p>Shaft shown in full C.C.W position</p>	 <p>PC board mounting details              Slant line area: solder land              Black area: do not solder and wire for electrical contact</p>
2	<p><b>Single-shaft, single-unit with push-on switch travel 0.5mm RK1191114001</b></p> 	 <p>Shaft shown in full C.C.W position</p>	 <p>PC board mounting detail              A slant line part: The solder land              Black part: Do not solder and wiring for electrical contact</p>
3	<p><b>Single-shaft, single unit with push-on switch travel 1.5mm RK1191124001</b></p> 	 <p>Shaft shown in full C.C.W position</p>	 <p>PC board mounting detail              A slant line part: The solder land              Black part: Do not solder and wiring for electrical contact</p>

## Product Varieties

In addition to the recommended products, the following specifications can also be accommodated.

### Total Resistance Variety

Total resistance(k $\Omega$ )	10	20	50
-------------------------------	----	----	----

### Resistance Taper

Resistance taper	15A	1B	3B
------------------	-----	----	----

### Detent and Attached Switch

Variety	Items	Detent	Attached switches travel	
			0.5mm	1.5mm
Single-shaft, Single-unit		Without		

### Dimensions of Shaft

Flat type

Unit:mm

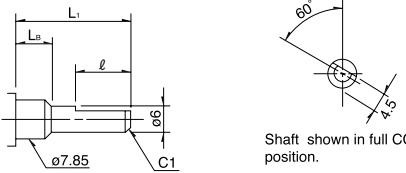

L <sub>1</sub>	L <sub>b</sub>	l
(15)	5	7
(20)	5	10

### Notes

- L<sub>b</sub> does not support M7(with Screws).
- Marked are specifications recommended by ALPS.

## Specification for Switch

### Mechanical Characteristics

Type	Travel (mm)	Pole-position	Rating	Changeover torque (Operating force)
Momentary push type	0.5 ± 0.3	SPST	DC 5V 0.1A (1mA 5V DC min.rating)	5 ± 2N
	1.5 ± 0.5			4 ± 2N

### Electrical Characteristics

Type	Contact resistance	Insulation resistance	Voltage proof
Momentary push type	100m $\Omega$ for initial period, 200m $\Omega$ after operating life	100M $\Omega$ min. Measured with a 250V DC megger.	300V AC 1 minute min.

### Durability

Operating life under load	Travel 0.5mm	The switch under a rated resistive load shall be subjected to a total of 100,000 cycles of operation at a speed of 600 to 1,000 cycles per hour. The contact resistance after testing should not exceed 200m $\Omega$ .
	Travel 1.5mm	The switch under a rated resistive load shall be subjected to a total of 20,000 cycles of operation at a speed of 600 to 1,000 cycles per hour. The contact resistance after testing should not exceed 200m $\Omega$ .

### Note

The operating current should be 10mA or greater.

Refer to P.346, 502 for resistance taper.

## Orders other than for recommended products

When ordering product varieties that are not listed in the Product Line, please specify by referring to the below example.

### Sample Part Number

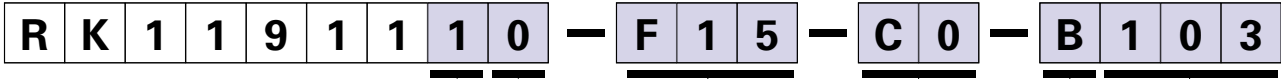

#### Switch Travel (mm)

Code	Switch
1	0.5
2	1.5

\*For "without switch" type, select 1.

#### Switch

Code	Switch
0	Without switch
4	With push-on switch

#### Length of the shaft (L, X mm)

Code	Length of the shaft
15	15
20	20

#### Detent

Code	Detent
C0	Without

#### Resistance taper

Code	Resistance taper
A	15A
B	1B
V	3B

B:For tone & general  
V:For vol.

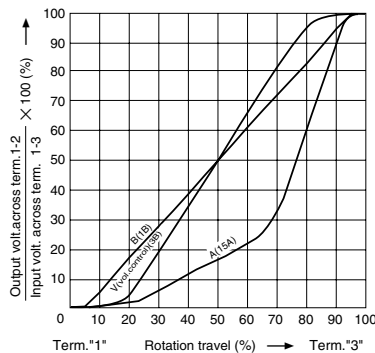

#### Total resistance

Code	Total resistance (kΩ)
103	10
203	20
503	50

#### Note

marked are specifications recommended by ALPS.







Rotary Potentiometers  
Slide Potentiometers

Metal Shaft  
Insulated Shaft  
Knob Operating

## List of Varieties

Rotary Potentiometers  
Slide Potentiometers

Metal Shaft  
Insulated Shaft  
Knob Operating

Type	9mm size metal shaft snap-in	9mm size metal shaft multi-ganged	11mm size metal shaft low-profile	11mm size metal shaft reflow	16mm size metal shaft	
Number of drive shafts	Single-shaft		Dual-shaft	Single-shaft		
Model	RK09L1	RK0971 RK0981	RK0972	RK117111	RK119	RK1631 1 RK1631 A
Photo						
Fixing method of bushing	The bushing can be screwed down		Bushing screw clamp	Bushing guide type		
Terminal mounting	Horizontal type	Vertical type	Horizontal type	Vertical type		
Attached switch	Without		Rotary switch 1	Momentary push switch		Without
			Push-on push-off switch 1			
			Momentary push switch 1			
Gang error applicable to Dual-unit parts for audio volume control purposes	- 40dB to 0dB 3dB max.		—————		- 40dB to 0dB 3dB max.	
Solder heat resistance	Manual soldering	350 max. 3s max.			350 ± 10 3 <sup>+1</sup> / <sub>0</sub> s	350 max. 3s max. Motor terminal: 360 max 2s max.
	Dip soldering	260 ± 5 , 5 ± 1s			—————	
	Reflow soldering	—————			Please see P.347	—————
Operating temperature range	- 10 to + 70	- 20 to + 70	- 30 to + 70	- 40 to + 85	- 10 to + 70	
Electrical performance	Rated power	0.05W				
	Residual resistance	10k < R < 50k 50k < R	20 max. 30 max. Nominal total resistance of 0.1% or less		R 10k 50 max. 10k < R 50k 80 max. 50k < R Nominal total resistance of 0.2% or less	R 10k 20 max. 10k < R 50k 30max. 50k < R Nominal total resistance of 0.1% or less
	Maximum attenuation (Volume control)		5k R < 10k 10k R < 50k 50k R < 100k 100k R	70dB min. 80dB min. 90dB min. 100dB min.		
	Insulation resistance	100M min. 250V DC				100M min. 500V DC
	Voltage proof	300V AC for 1minute				500V AC for 1minute
Mechanical performance	Stopper strength	0.5N·m( With push-lock mechanism type: 0.4N·m )			0.5N·m	0.9N·m
	Push-pull strength	80N max.	100N max.			
	Vibration	10 to 55 to 10Hz/min., the amplitude is 1.5mm for all the frequencies, in the 3 direction of X, Y and Z and for 2 hours respectively				
Environmental performance	Cold	- 20 ± 2 for 96h	- 30 ± 2 for 96h		- 40 ± 2 for 240h	- 20 ± 2 for 96h
	Dry heat	70 ± 2 for 96h			85 ± 2 for 240h	70 ± 2 for 96h
	Damp heat	40 ± 2 , 90 to 95%RH for 96h			60 ± 2 , 90 to 95%RH for 240h	40 ± 2 , 90 to 95%RH for 96h
Page	323	327	339	343	348	

### Push-on Switch Specifications

Items	RK097		RK117		RK119	
Contact arrangement	Single pole and single throw ( Push on )					
Travel( mm )	0.5	1.5	0.5	1.5	0.5 ± 0.3	1.5 ± 0.5
Operating force ( N )	4 <sup>+1</sup> / <sub>2</sub>	5 ± 2	6 ± 3	5 ± 2		4 ± 2
Rating	0.5A 12V DC		3A 16V DC		0.1A 5V DC (1mA 5V DC min.ratings)	
Contact resistance	100m for initial period;200m after operating life					
Operating life	10,000 times min.	20,000 times min.	10,000 times min.	20,000 times min.	100,000 times min.	20,000 times min.

Metal Shaft Potentiometers Attached Parts .....363  
Metal Shaft Potentiometers Cautions .....364, 365

### Notes

1. For the switch attached, the single-shaft or inner shaft of the dual-shaft type can be chosen.
2. The operating temperature range for automotive applications can be raised upon request. Please contact us for requirements of this kind.

# Soldering Conditions

## Example of Reflow Soldering Condition

1. Heating method: Double heating method with infrared heater.
2. Temperature measurement: Thermocouple 0.1 to 0.2 CA (K) or CC (T) at soldering portion (copper foil surface). A heat resisting tape should be used for fixed measurement.
3. Temperature profile

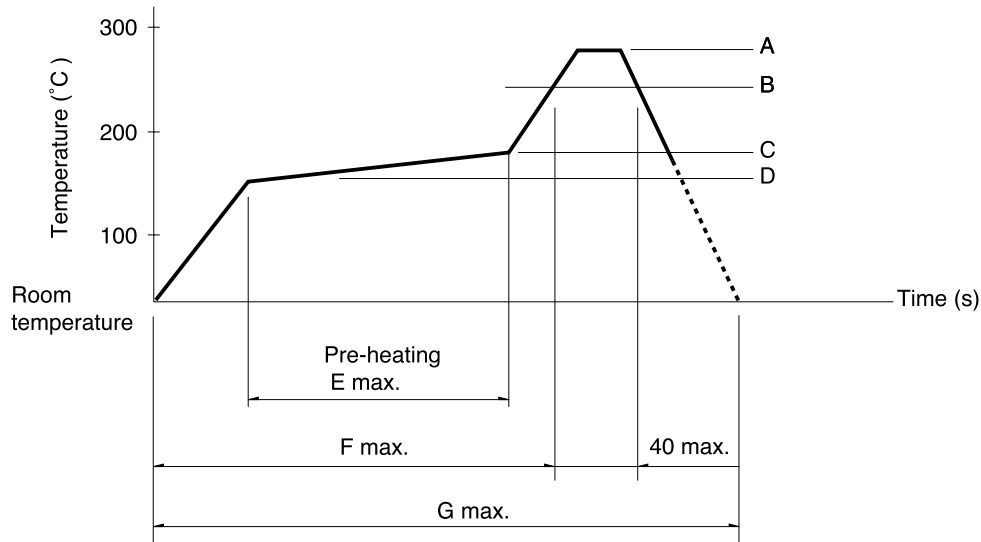

Series (Reflow type)	A ( ) 3s max.	B ( )	C ( )	D ( )	E (s)	F (s)	G (s)
RK119	260	230	180	150	120	—	240

### Notes

1. The condition mentioned above is the temperature on the mounting surface of a PC board. There are cases where the PC board's temperature greatly differs from that of the switch, depending on the PC board's material, size, thickness, etc. The above-stated conditions shall also apply to switch surface temperatures.
2. Soldering conditions differ depending on reflow soldering machines. Prior verification of soldering condition is highly recommended.

Rotary Potentiometers  
Slide Potentiometers

Metal Shaft  
Insulated Shaft  
Knob Operating